

Simulation of a New PZT Energy Harvester with a Lower Resonance Frequency Using COMSOL Multiphysics®

H. Elbahr^{1,*}, T. A. Ali^{1,2}, A. Badawi¹, S. Sedky¹

¹Zewail City of Science and Technology, Cairo, Egypt.

² Cairo University, Cairo, Egypt.

*helbahr@zewailcity.edu.eg

Abstract: Energy harvesting from environmental vibration nowadays is feasible because of natural oscillations like that caused by air or liquid flow and by exhalation or the heartbeat of a human body. This vibration frequency is typically low (in order of less than 1 kHz). Accordingly, low frequency vibration based energy harvesting systems are an important research topic; these systems can be used for wearable or implantable devices.

Piezoelectric vibration based harvesters are not expensive and do not require external voltage sources, making them a viable alternative to implement energy harvesting system.

In this paper a macro-scale unimorph piezoelectric cantilever with non-traditional geometry is investigated for generation of electrical energy by using the software COMSOL Multiphysics 4.4 FEA. The piezoelectric energy harvester consists of an active piezoelectric layer (PZT-5H), steel substrate and titanium proof mass.

The proposed structure is simulated and the results are compared with other traditional geometries.

Simulation results demonstrated that the new cantilever structure has a lower resonance frequency and higher average strain than the rectangular structures, which makes it suitable for wearable or implantable devices.

Keywords: COMSOL Multiphysics, Energy harvesting, unimorph cantilever, piezoelectric energy harvester.

1. Introduction

With the limited capacity of finite power sources, the inconvenience of replacing battery in hard-to-reach embedded devices and the need of supplying energy for a lifetime of a system, there is a great need for self-powered devices.

Energy harvesters became a good alternative for conventional batteries, since they open new perspectives in terms of long-term power supply

for vast number of applications, including embedded, implanted sensor nodes for medical applications, distributed wireless sensor nodes for structural health monitoring, and battery recharging [1]. The most common sources of such energy are solar radiation, temperature gradient, vibration, and RF emissions [2].

The vibration energy is the most widespread and wasted energy in the environment. This vibration can be converted into electrical energy by three main harvesting mechanisms: electrostatic (capacitive), electromagnetic, and piezoelectric. Electrostatic energy harvesters are based on the changing capacitance of a variable capacitor whose dimensions changes with vibrations [3, 4]. Electromagnetic energy harvesting can be achieved by changing the magnetic field around a conductor to induce voltage on it. This can be done with permanent magnets, a coil and a resonating cantilever beam [5]. Piezoelectric materials produce electric charges when strained. This is used in converting vibrational energy to electrical energy [6].

Piezoelectric energy harvesters are mostly used because piezoelectric materials have a large power and are simple to use in applications. The vast majority of piezoelectric energy harvesting devices uses a cantilever beam structure [7].

A cantilever beam, by definition, is a beam with a support at one end, and is often referred to as a “fixed-free” beam. Cantilever beam structure consists of one or more layers bonded to an elastic metal layer in order to increase the overall elasticity of the structure and overcome the brittleness of piezoelectric materials; it can be unimorph, bimorph or multimorph cantilever.

In this paper an unimorph cantilever beam with a non-traditional geometry is designed and simulated with COMSOL for the conversion of mechanical energy into electrical energy and to achieve a larger strain and voltage at lower frequency.

2. Theoretical Background of Piezoelectric Transducer

Piezoelectric materials produce electrical charge when it is mechanically deformed; **The IEEE standard on piezoelectricity gives different forms of piezoelectric constitutive equations.** The form used here is **strain-charge form**, and the equations are as follows:

$$S = s^E T + d \bar{E} \quad (1)$$

$$D = d T + \varepsilon^T \bar{E} \quad (2)$$

S : Mechanical strain.

s^E : Elastic compliance tensor (1/stiffness), (Pa^{-1}).

T : Mechanical stress vector (Nm^{-2}).

\bar{E} : Electric field vector (Vm^{-1}).

D : Electrical Displacement (Cm^{-2}).

ε^T : Dielectric permittivity tensor (Fm^{-1}).

d : Electro-mechanical coupling factor, (CN^{-1}).

The second term in the right side of first equation represents the piezoelectric coupling term, which provides the mechanism for energy conversion.

The property variable like (d) has 2 prefix

$i, j \rightarrow d_{i,j}$.

where i is polarization direction (usually 3) and j is strain direction.

Typically, two different modes can be used in the design of a piezoelectric harvester. The first one is longitudinal mode (d_{33}) where the polarization of the beam is laterally developed in the deposited film. The second mode, which is commonly used, is transversal (d_{31}) where the polarization of the beam is perpendicular to the deposited film.

One of the most important design parameters in designing a vibration energy harvesting device is the resonant frequency. The electrical output energy attains a peak value if the vibration frequency of the environment matches the resonant frequency of the cantilever, and dies out dramatically when it deviates from the resonant frequency of the device. A lower resonant

frequency is desirable to be closer to most of environmental vibration sources.

A cantilever beam can have many different modes of vibration, each with a different resonant frequency. The first mode of vibration has the lowest resonant frequency, and typically provides the most deflection and therefore the most electric energy [8].

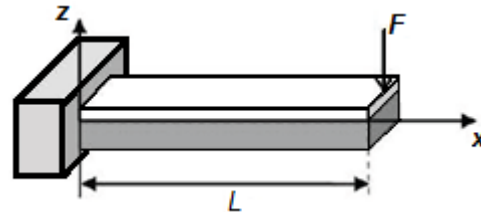

Figure1. Configuration of piezoelectric cantilever beam

The resonant frequency (f_n) can be calculated by following equation [9].

$$f_n = \frac{v_n^2}{2\pi L^2} \sqrt{\frac{D_p}{m}} \quad (3)$$

where

$$m = \rho_p t_p + \rho_s t_s \quad (4)$$

and

$v_n = 1.875$ for first mode.

m is the mass per unit area which is calculated by the thicknesses and densities, ρ_p and ρ_s are the densities of the piezoelectric and substrate, material respectively.

The bending modulus (D_p) is a function of Young's modulus and thickness and is expressed by

$$D_p = \frac{E_p^2 t_p^2 + E_s^2 t_s^2 + 2E_p E_s t_p t_s (2t_p^2 + 2t_s^2 + 3t_p t_s)}{12(E_p t_p + E_s t_s)} \quad (5)$$

where E_p and E_s are Young's modulus of piezoelectric and substrate materials and their thicknesses, t_p and t_s , on the tip of the cantilever. Hence the variation of resonant frequency as follows

$$f_n \propto \frac{1}{L^2} \sqrt{t_p} \sqrt{t_s} \quad (6)$$

3. Use of COMSOL Multiphysics

The piezoelectric energy harvester with proposed and rectangular shapes were designed and simulated in COMSOL MultiPhysics 4.4 using piezoelectric devices module as 3D configuration as shown in Figure 2a and Figure 2b. The goal is to study the deformation, strain,

generated voltage, and charge distribution of piezoelectric energy harvesters with the two shapes and compare them.

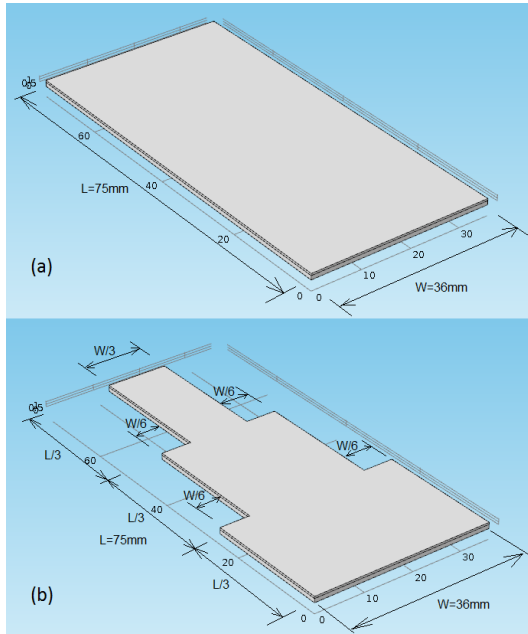

**Figure 2. (a) The rectangle geometry
(b) The proposed geometry**

3.1 Subdomain setting

The Structure is composed of two subdomains; the first is substrate layer which is chosen to be steel, and the second is piezoelectric layer made of Lead Zirconate Titanate (PZT-5H).

3.2 Boundary Conditions

The model was simulated such that one end of the unimorph cantilever is fixed (the $W/3$ side) while other is free to vibrate. The fixed constraint condition is applied to the vertical faces of both layers, while all other faces are free of displacement. The d_{31} mode is selected by applying floating potential for the upper face and grounding the lower face of the piezoelectric layer while all other faces of the piezoelectric layer are kept at zero charge constraint. The body load F (0.1N) is applied as an input to the piezoelectric layer to induce a strain.

3.3 Meshing

The model must now be meshed so the geometry of the Structure can be reduced to a group of simpler finite element bricks and

presented to the solver for finite element analysis. The model is meshed in tetrahedral blocks with fine element size, as shown in Figure 3.

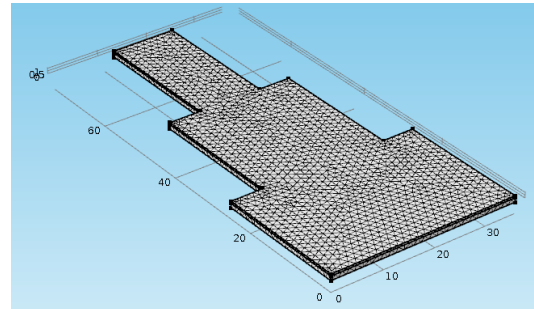

Figure 3. Meshed Model

4. Simulation Results

4.1 Eigenfrequency Analysis

An eigenfrequency analysis was conducted in order to identify the bending resonance frequencies of the piezoelectric device. The first four resonance frequencies are shown in Figure 4(a,b,c,d), it is good to mention that the fourth mode suffers from bending in xy -plan only.

Figure 5, Figure 6, and Figure 7 show the variation of resonant frequencies with beam length, width and thickness, respectively. The resonant frequency increases with increasing the cantilever thickness, decreases with increasing the cantilever length, and slightly invariant to the width of cantilever, as predicted from equation (6). It is clear that with the same width, length, and thickness the proposed geometry has a lower resonant frequency than generated from the rectangle one.

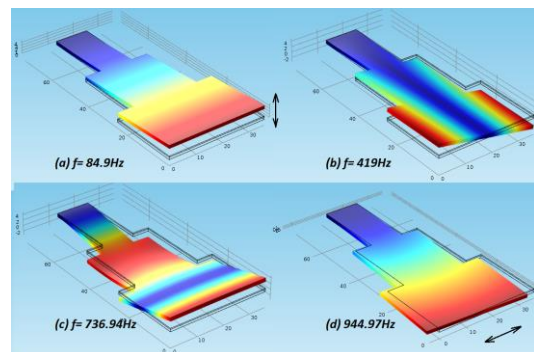

**Figure 4. (a) First mode (b) Second mode
(c) Third mode (d) Fourth mode**

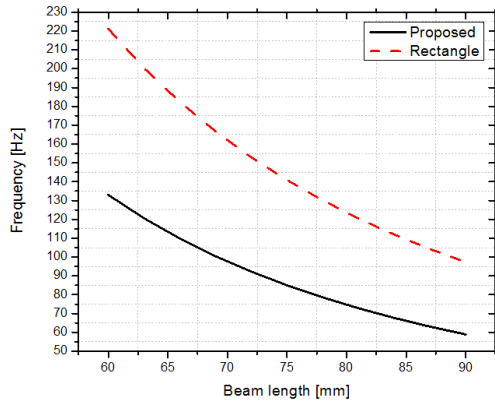

Figure 5. Resonance Freq. versus beam length at $W=36\text{mm}$, $t_p=0.4\text{mm}$

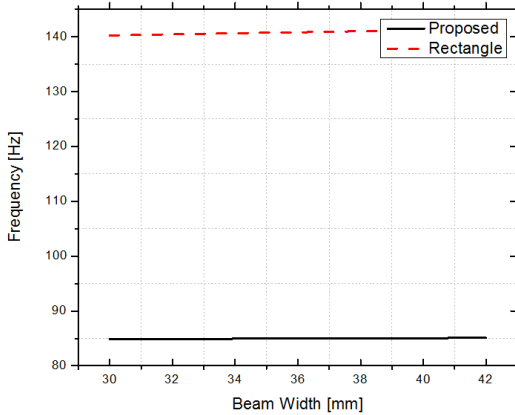

Figure 6. Resonance Freq. versus beam width at $L=75\text{mm}$, $t_p=0.4\text{mm}$

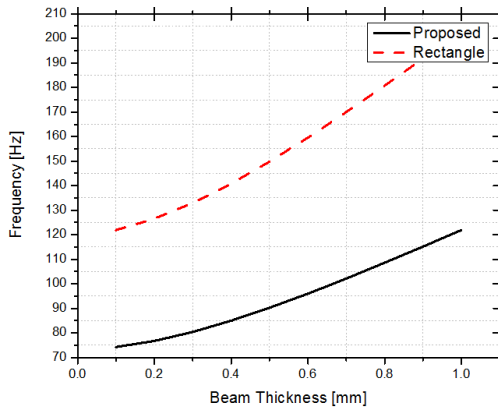

Figure 7. Resonance Freq. versus beam thickness at $W=36\text{mm}$ and $L=75\text{mm}$

When the structure becomes fixed from the wide end (the W side), the first resonant frequency becomes 210.6 Hz instead of 85 Hz

(first resonant frequency of structure with fixed narrow side) at the same values of beam length, width and thickness.

4.2 Stationary Analysis

The design parameters (length and width) of cantilever would affect the charge, voltage and energy produced by a unimorph cantilever. The variations are shown below.

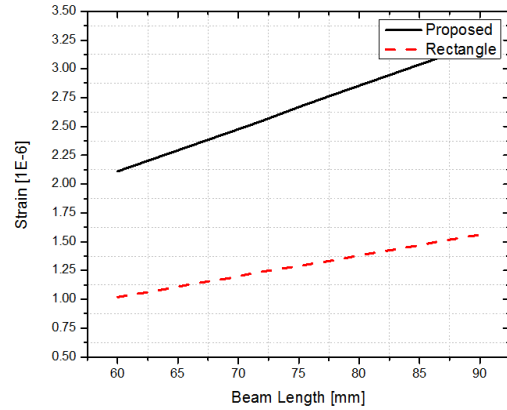

Figure 8. The strain versus beam length at $W=36\text{mm}$, $t_p=0.4\text{mm}$

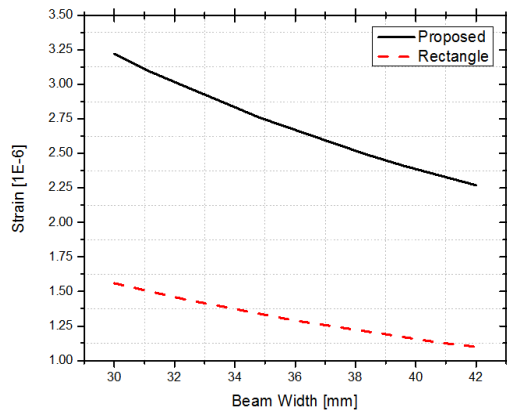

Figure 9. The strain versus beam width at $L=75\text{mm}$, $t_p=0.4\text{mm}$

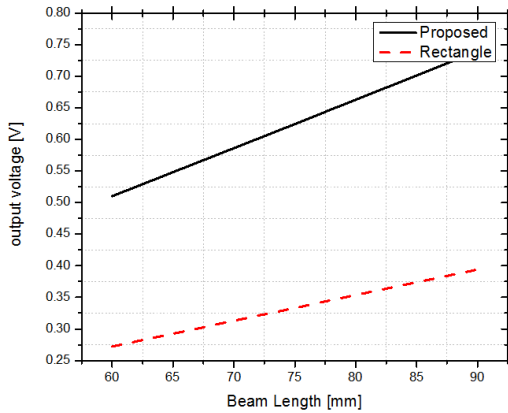

Figure 10. The output voltage versus beam length at $W=36\text{mm}$, $t_p=0.4\text{mm}$

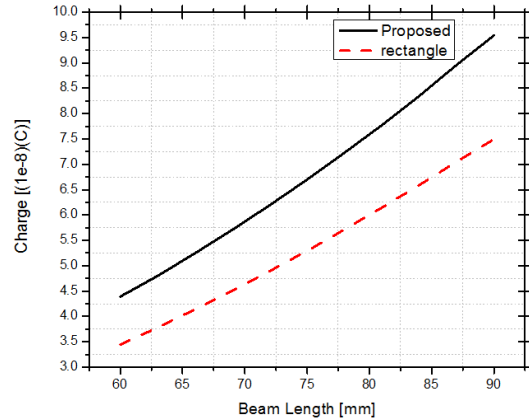

Figure 12. The generated charge versus beam length at $W=36\text{mm}$, $t_p=0.4\text{mm}$

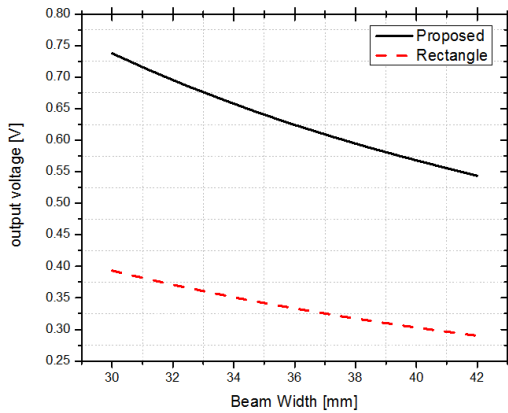

Figure 11. The output voltage versus beam width at $L=75\text{mm}$, $t_p=0.4\text{mm}$

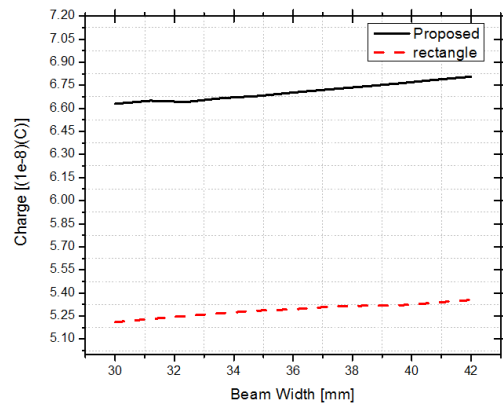

Figure 13. The generated charge versus beam width at $L=75\text{mm}$, $t_p=0.4\text{mm}$

As shown from Figure 8, Figure 9, Figure 10, and Figure 11, the proposed geometry has a larger strain and output voltage than obtained from the rectangle shape. The same proposed structure but fixed from the wide side (the W side) generates a voltage range similar to that obtained from the rectangle shape.

After integrating the surface charge density over the piezoelectric surface, the total stored charge was calculated. Increasing the beam length and width increases the total charge, as shown in Figure 12 and Figure 13.

The total stored energy was calculated using the following equation:

$$E = \frac{1}{2} QV$$

Where Q is the accumulated charge (C), V is the open circuit voltage (Volts), and E is total stored energy (J).

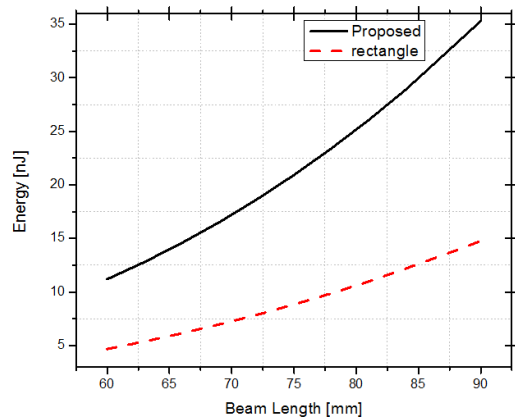

Figure 14. Energy versus beam length at $W=36\text{mm}$, $t_p=0.4\text{mm}$

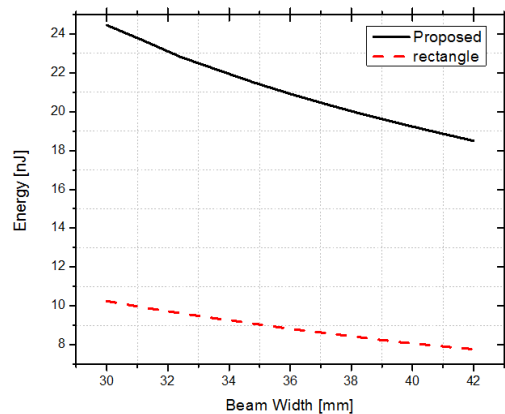

Figure 15. Energy versus beam width at $L=75\text{mm}$, $t_p=0.4\text{mm}$

5. Conclusions

An energy harvester based on piezoelectric cantilever with dimensions 75mm x 36 mm x 0.4 mm is designed and simulated in COMSOL MultiPhysics.

The simulation results (resonant frequency, strain, voltage, charge, and energy) sensitivity were analyzed versus proposed cantilever design parameters (L and W) variations, and compared with the results of rectangular shape cantilever.

The proposed geometry can operate from 55 Hz to 130 Hz and generates output voltage within the range of 0.5 to 0.75V.

This non-traditional geometry has a lower resonant frequency while achieving higher output voltage and energy than the rectangular one.

6. References

1. S. Priya and D. J. Inman, "Energy Harvesting Technologies", Springer, New York, 2009.
2. E. P. Yeatman, "Micro-engineered devices for motion energy harvesting," in Electronic Devices meeting, *IEEE International*, Washington, DC, 2007.
3. C.B. Williams and R.B. Yates, "Analysis of a micro-electric generator for Microsystems", *Sensors and Actuators A*, **Vol. 52**, pp. 8-11, 1996.
4. N. N. H. Ching, H. Y. Wong, W. J. Li, P. H. W. Leong and Z. Wen, "A laser-micromachined multi-modal resonating power transducer for wireless sensing systems", *Sensors and Actuators A*, **Vol. 97-98**, pp. 685-690, 2002.
5. S. Chalasani, J. M. Conrad, "A Survey of Energy Harvesting Sources for Embedded Systems," *IEEE In Southeastcon*, 2008.
6. R. S. Bindu, Kushal, M. Potdar, "Study of Piezoelectric Cantilever Energy Harvesters", *international journal of innovative research and development*, ISSN 2278 – 0211, 2014.
7. D. Poria, Monika, R. Sharma, D. Rohilla, M. kumar, "Modeling and Simulation of Vibration Energy Harvesting of MEMS Device Based on Epitaxial Piezoelectric Thin Film", *International Journal of Advanced Research in Computer Science and Software Engineering*, 2012.
8. S. Roundy, P. K. Wright, "A piezoelectric vibration based generator for wireless electronics", *Smart Materials and Structures*, 13 (2004) 1131-1142.
9. X. Li, W.Y. Shih, I.A. Aksay and W.-H. Shih, "Electromechanical behavior of PZT-brass unimorphs," *J. Am. Ceram. Soc.*, 82(7), pp. 1733-1740, 1999.

10. Appendix

Symbol	Description	Value
L	Beam Length	75mm
W	Beam Width	36mm
t_p	Thickness of piezoelectric material	0.4mm
t_s	Thickness of substrate material	0.8mm
ρ_p	Density of piezoelectric material	7500 Kg/m ³
ρ_s	Density of substrate material	7850 Kg/m ³
E_p	Young's Modulus of piezoelectric material	64 GPa
E_s	Young's Modulus of substrate material	200 GPa